

Centre de Transformation du Mans

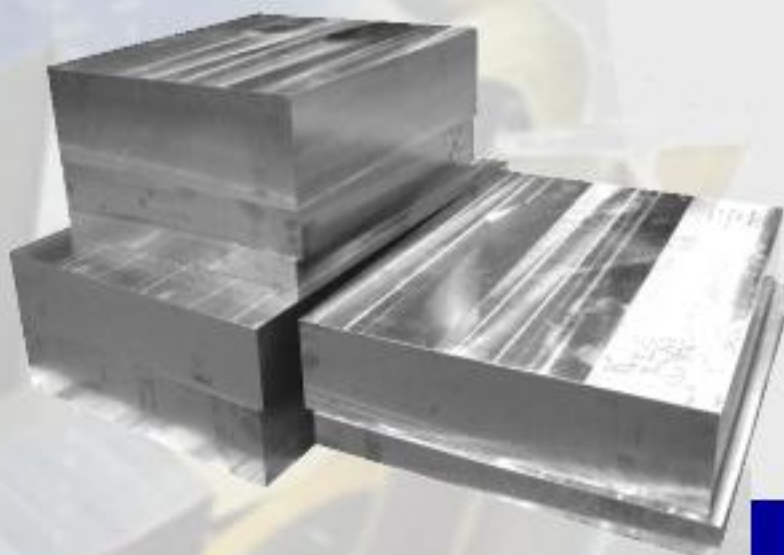

Nos réalisations

Carcasses de moule

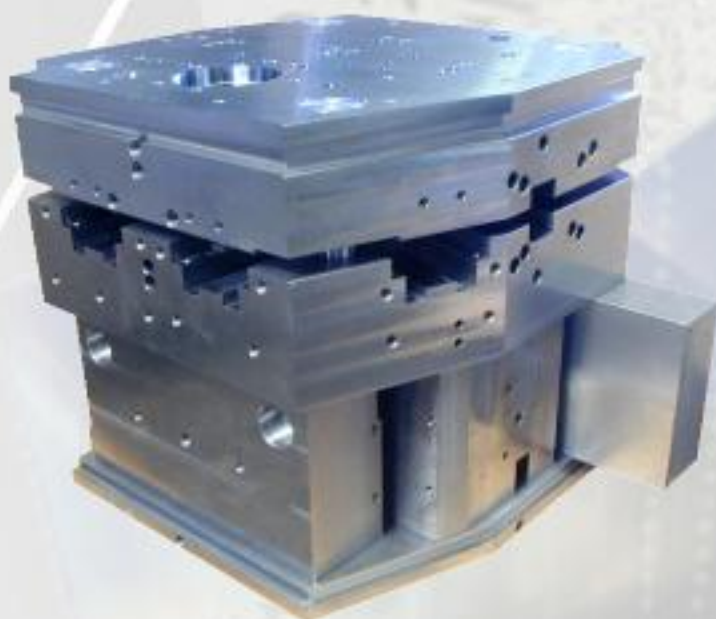

Nos réalisations

Semelles d'outils

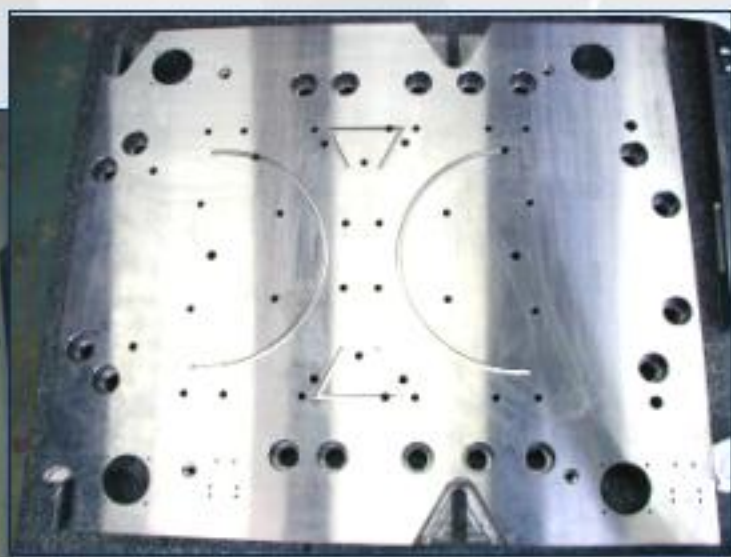
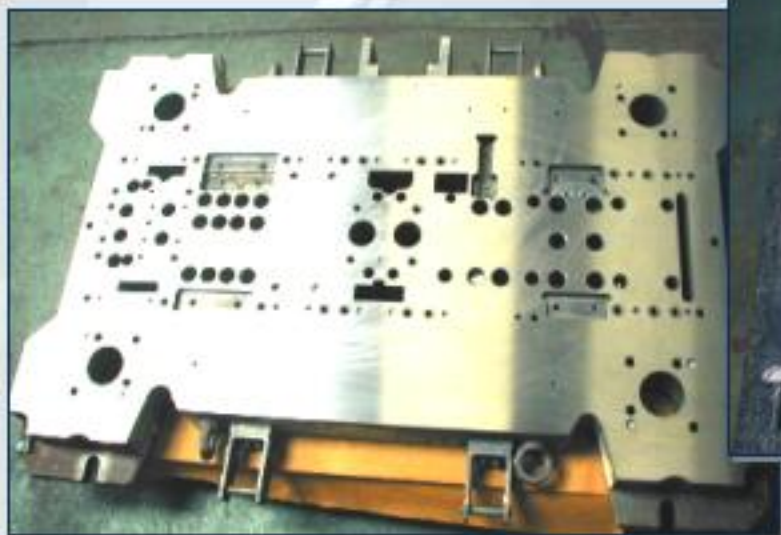

Mécanique générale



Le Magasin

Manutention
jusqu'à 56 Tonnes

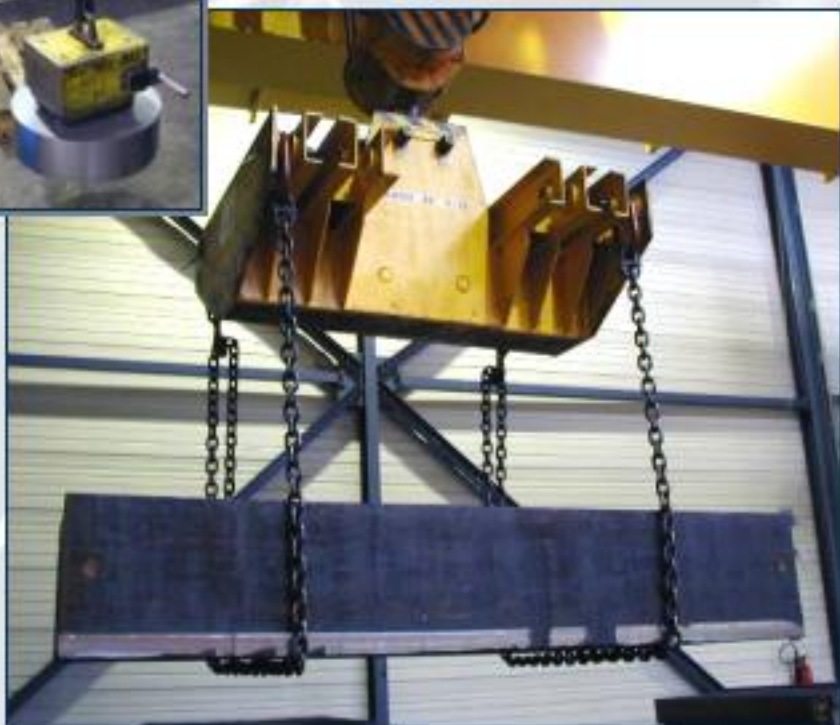

Sciage (14 machines)
capacités maxi : 1250 x 2000 x 6000 mm

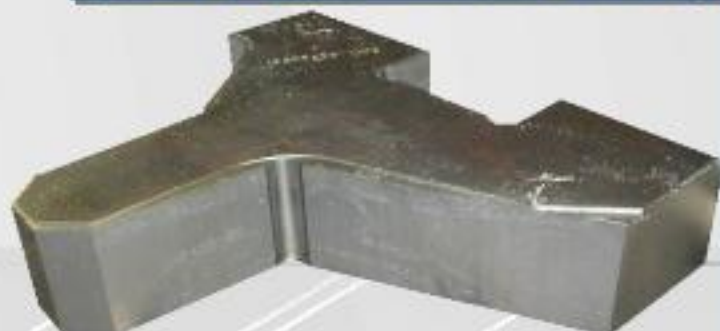
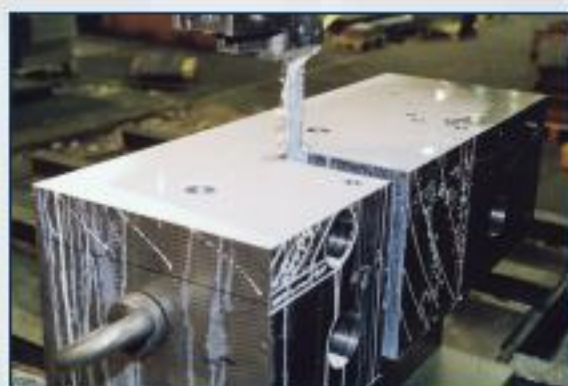

Possibilité de sciage de forme



Le Cubage

Fraisage (13 machines)

de 100 x 100 mm à 4200 x 2200 mm, jusqu'à 30 tonnes



Rectification (3 machines)

de 100 x 100 mm à 3000 x 1500 mm



Micro-blocs

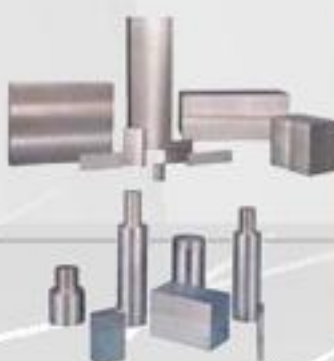

Travaux suivant Plans

Tournage (2 machines)

\varnothing 80 à \varnothing 500 mm



Centres d'usinage (4 machines)

capacités maxi : 1200 x 1900 x 5000 mm



Forage (1 machine)

\varnothing 4 à \varnothing 32 mm / Prof. maxi : 1500 mm



Vos contacts

A votre disposition ..

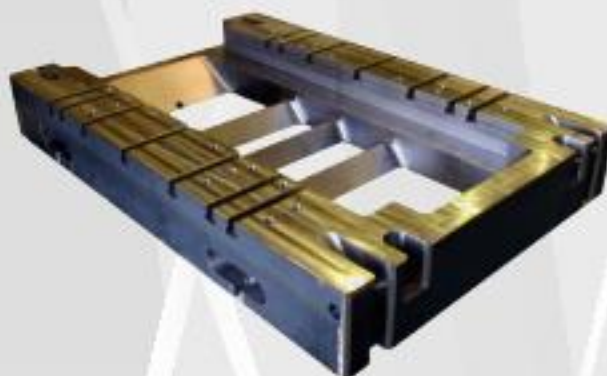

Site certifié ISO 9001 par LRQA

Pré-usinés – Oxycoupage

eMail : lemanspu@thyssen.fr

Tél : **02 43 40 56 56**

Travaux suivant Plans

eMail : lemanssts@thyssen.fr

Tél : **02 43 40 56 63**

Programmation

FAO : 4 Stations GOELAN 4.6

Interfaces : IGES – DXF – DWG

Echange de fichiers

lignes haut débit

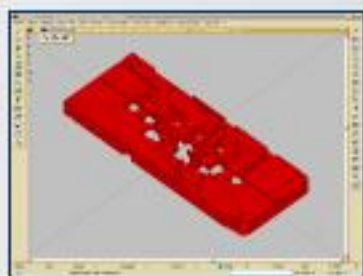

Sites en France

Maurepas (*Siège Social*)

Bordeaux

Bourges

Brive

Charleville

Cluses

Hénin-Beaumont

Le Mans

Lyon

Marseille

Mulhouse

Nancy

Nantes

Pau

Thiers

Toulouse

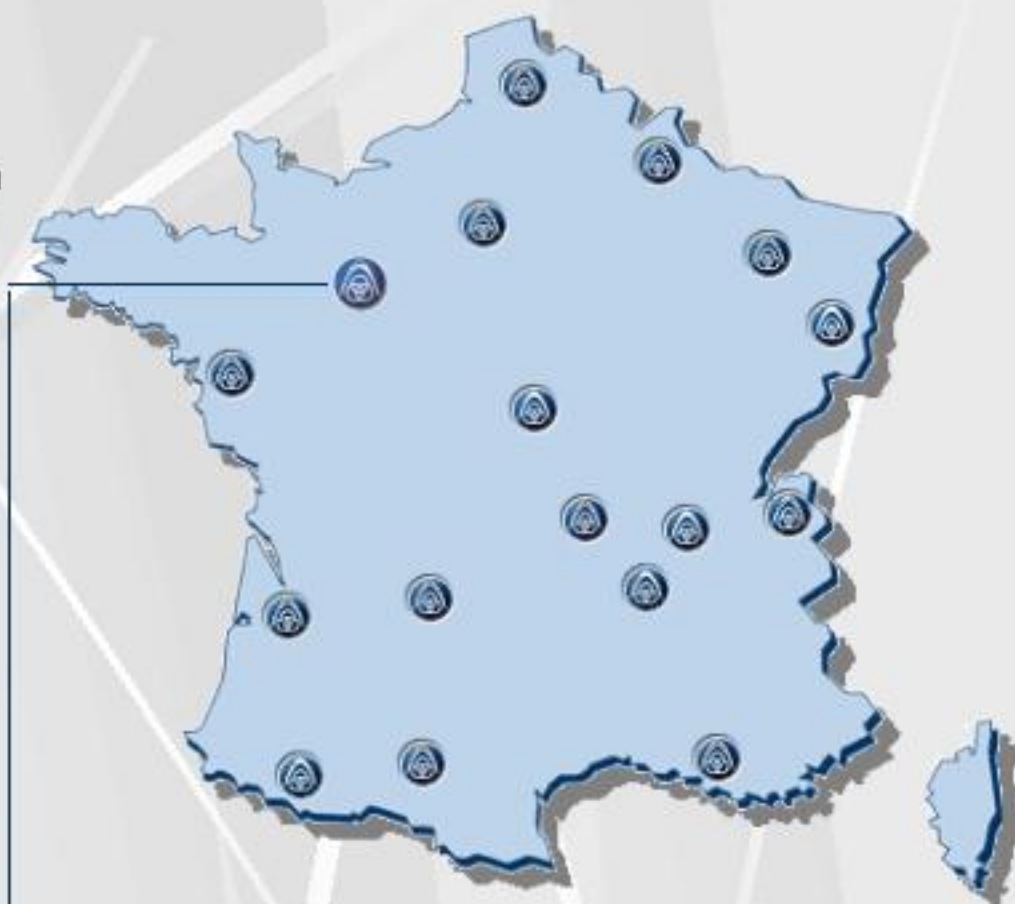

**Centre de Transformation
du Mans**

**70-72, rue Pierre Martin
Z.I. Sud**

72000 Le Mans

Tél.: 02 43 40 56 56

Fax : Selon service

